



WITTENSTEIN

# WITTENSTEIN group Company & portfolio



## Contact

WITTENSTEIN SE  
Walter-Wittenstein-Straße 1  
97999 Igersheim, Germany

Email: [info@wittenstein.de](mailto:info@wittenstein.de)  
Tel. : +49 7931 493-0  
Fax : +49 7931 493-10200



# Contents

WITTENSTEIN - Drivers of innovation in cybertronic drive technology	4
The WITTENSTEIN group	6
WITTENSTEIN service concept	10
WITTENSTEIN sizing tools	12
WITTENSTEIN Service Portal	13
cynapse® – the smart feature from WITTENSTEIN	14
Hygienically safe production	16
WITTENSTEIN alpha – company & portfolio	20
WITTENSTEIN alpha on all axes	22
Low-backlash planetary gearboxes	24
Right-angle gearboxes	28
Worm gearboxes	31
Linear systems	32
Servo actuators	34
WITTENSTEIN cyber motor – company & portfolio	38
Servo motors & actuators	40
Special motors	42
Customized drives	43
Servo drives	44
Servo drive systems	45
Accessories for servo drive systems	45
WITTENSTEIN galaxie – company & portfolio	48
Galaxie®	50
Miniaturized Galaxie®	52

# WITTENSTEIN

With our subsidiaries, dealerships and production locations, we boast a global presence so that we can offer local support to all our customers.

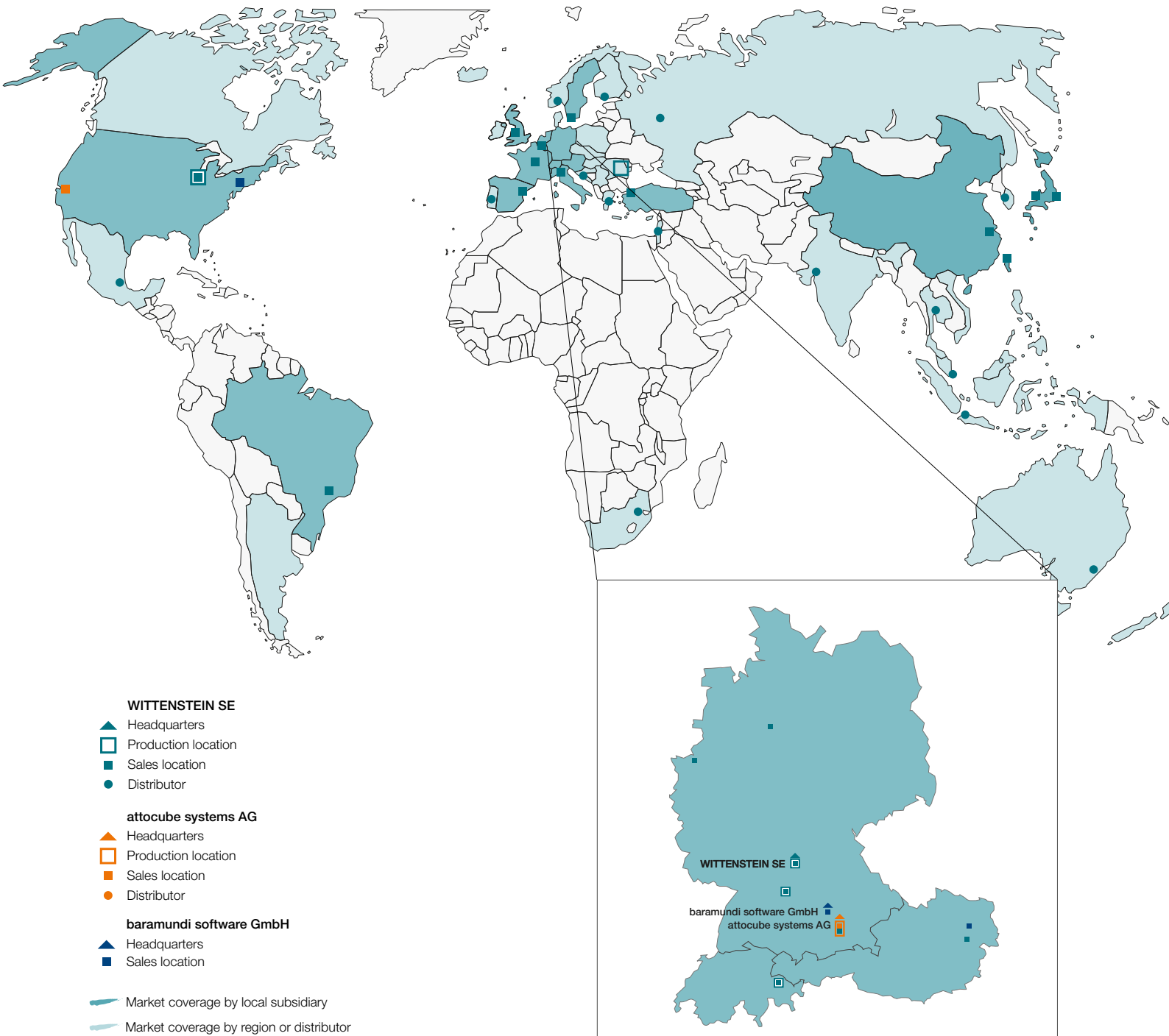

## Drivers of innovation in cybertronic drive technology

We develop, produce and sell systems and solutions for highly dynamic motion, maximum-precision positioning and intelligent networking in the field of mechatronic and cybertronic drive technology. Our aim is to provide you with innovative, future-proof solutions that will help you to stay ahead of the game. To this end, we have combined strategic business divisions with specific core competencies under one roof.

Our products can be found in industry, in space and underground. We offer products such as high-precision planetary gearboxes, complete electromechanical drive systems as well as AC servo systems and motors. Our areas of application include robotics, machine tools, medical technology and the aerospace industry.



# The WITTENSTEIN group

Strategic business divisions



alpha

WITTENSTEIN alpha GmbH  
High-precision servo drives and linear systems



cyber motor

WITTENSTEIN cyber motor GmbH  
Highly dynamic servo motors and drive electronics



galaxie

WITTENSTEIN galaxie GmbH  
Superior gearboxes and drive systems





WITTENSTEIN | motion control

WITTENSTEIN motion control GmbH  
Drive systems for the most extreme environmental requirements



**attocube**

WITTENSTEIN group

attocube systems AG  
Nanoprecision drive and measurement technology solutions



**baramundi**

WITTENSTEIN group

baramundi software GmbH  
Secure management of the IT infrastructure in offices and production



## Facts and figures

As at March 31, 2023

Sales revenue in EUR

**519.1 million**

Equity ratio

**56%**

Employees worldwide

**2883**

Training rate

**6.3%**

# The WITTENSTEIN group

## Areas of expertise

### Mechanical and systems engineering



For decades, we have served as a competent partner to companies involved in the development, design and manufacture of machines for factory and process automation. During this time we have built up unrivaled know-how in a variety of industries. Our customers profit from our outstanding expertise in the following fields:

### Automation, robotics, handling



### Plastics & rubber processing



### Semiconductors & electronics assembly

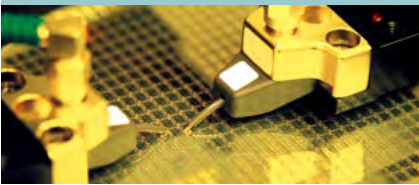

### Woodworking



### Food and packaging



### Machine tools



### Other industries



### Aerospace



### Automotive and e-mobility



### Energy



The aviation industry must develop ever more efficient aircraft, without compromising on safety. Thanks to their excellent power-to-weight ratio and reliability, our mechatronic systems contribute towards achieving and exceeding this objective. Our EASA approval and global service network enables us to offer all services, for our entire product range, to provide system suppliers, aircraft manufacturers and airlines with reliable mechatronic driver capacity for the entire life cycle of an aircraft.

Since 2006, WITTENSTEIN has set benchmarks in power-to-weight ratio, efficiency and intelligence for powertrains of electric and hybrid vehicles. By way of example, we offer traction drives, generators and electric drives for turbochargers and compressors, including intelligent control software. Our unique engineering solutions and serial products are specialized for space-restricted applications with small serial quantities.

We have long been working successfully with our customers on solutions for energy-efficient drives, new generations of power generators and energy recovery systems for many sectors. Thanks to their extremely high resistance to radioactivity, our radiation-proof rotary servo motors, actuators and generators open up completely new possible applications for nuclear power plant operators. On request, we build products in strict compliance with IEEE guidelines and explosion-proof to ATEX guidelines.





## Medical technology



We are an experienced and innovative partner in areas of medical technology, in which mechatronic drive solutions play an important role. For example, we have been developing and producing motors for various cardiac support systems for over 20 years. The drives are wear-free while also being extremely light and compact. They have now been used for well over 1000 patients.

## Measurement and testing technology

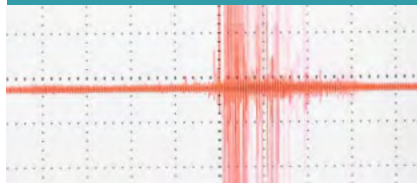

Modern production processes are increasingly complex. To control them accurately and reliably, the measuring and testing technology must be taken to new levels of precision and compactness. Our IDS3010 sensor enables dynamic, nanoprecise measurements in industrial applications for the first time. Our ultra-compact, customized drives simultaneously open up new possibilities for developing systems and equipment – even in extreme environmental conditions.

## Nanotechnology

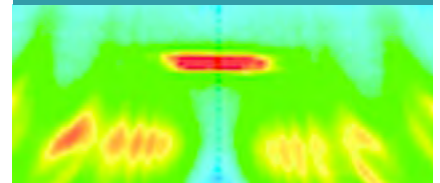

In order to record, research and further develop the nanotech world, you need instruments that work reliably even in the subatomic range. For over 10 years now, we have been developing and producing nano-precise sensor, actuator and microscopy solutions that push the limits of what is physically and technically possible. This work is interdisciplinary and innovative: We are ready to forge new and highly innovative paths with our customers.

## Oil and gas exploration



The harsh ambient conditions in the oil and gas industry place stringent demands on machines and systems: Our rotary servo motors and generators are available with and without housing, are highly shock and vibration-resistant and enable stator winding temperatures up to 240°C and ambient pressures up to 2100 bar. Specifically to enable oil and gas to be processed and extracted on land or below the ocean surface, we offer highly integrated mechatronic systems with extremely robust designs and high-precision calibrations.

## Simulation



Flight simulators enhance air safety significantly. These can be used to provide civilian and military pilots with practical instruction and training. Control Loading Systems are the sensitive human-machine interfaces in such simulators. We offer our customers these systems from a single source, including all the integrated hardware and peripherals as well as the necessary software systems and programming for aircraft type-specific databases.

## Digitalization



Digitalization is a chance to make growing complexity and the increasing trend towards mass customization manageable. This can only happen within a digitally networked manufacturing environment. That is why we develop a broad range of products and solutions for manufacturing environments in which production machinery and logistics systems are linked together and will have the capability to organize themselves in the future. We also offer our customers digital services which support condition monitoring or predictive maintenance, for instance, as well as attractive online tools that provide valuable assistance from a product finder to after-sales.

## Marine industry



The electrification of boats is a reality today, which involves both propulsion for increased environmental sustainability and the accessories of larger yachts due to the technical advantages over traditional hydraulic solutions. The WITTENSTEIN group has been active in the sector for more than a decade. As a partner, we understand and meet the needs of the marine industry. Our products are extremely compact, efficient and really silent, for greater comfort on board. Our 30 years of experience in the design of mechatronic products for demanding applications guarantees the quality and reliability needed for the marine industry.

## Battery production



Maximum throughput with a high level of economic efficiency and flexibility is a key factor in the battery manufacturing industry. These requirements can be met by the extensive product portfolio of the whole WITTENSTEIN group and its professional expertise. From cell production to cell and pack assembly, and right through to general automation technology, we take your application to the next level with our innovative solutions. This ensures that the demand for reliability and maximum precision over the entire period of use is met in combination with excellent reproducibility.

## Attractions industry



More than a stopover. People want to take a short vacation together with their family or friends, looking for more thrills and fun. New parks and resorts worldwide are opening their doors for an epic adventure. More real. More intense. More thrills. An experience like never before. Themes and attractions let visitors plunge into history. Film heroes and mythical creatures come alive while a journey into the future creates a once-in-a-lifetime experience.

# WITTENSTEIN service concept

## PRE-SALES

### Planning



#### Consulting expertise

- Optimum solutions thanks to professional application calculations and drive sizing
- Customized solutions and maximum innovation

#### Customer training and webinars

- Tailored content and specific training programs
- Recordings of WITTENSTEIN webinars to enable familiarization with products and solutions

#### CAD POINT

- Technical data sheets and 3D data – find the right information with just a few clicks

#### cymex® select

- The innovative quick sizing tool
- Efficient and customizable product selection in seconds
- Dimensional drawing and CAD data with a single click

### Investment



#### cymex®

##### Optimization of your drive train

- cymex® – the tried-and-tested software for drive system optimization
- cymex® enables straightforward dimensioning and evaluation of the complete drive train (application + transformation + motor + gearbox)
- Support and extensive design experience

#### speedline® service

- In time-critical situations, our speedline® service ensures your productivity and delivers the time savings that you require
- Coordination of the complete order from request to delivery, including technical clarification
- Individual pick-up and return service for additional time savings

Our services at a glance



## AFTER-SALES

### Usage



#### Professional support for the best possible start

- Assistance with installation and commissioning
- Individual training in commissioning
- Operating manuals with information regarding commissioning and installation
- Optimum integration of the system in your application

#### WITTENSTEIN Service Portal

- Support throughout the entire life cycle of your WITTENSTEIN product
- Instant access to product information
- Quick assembly and commissioning
- Play IIoT with Smart Services

### Re-investment



#### Maintenance

- Proactive measures to minimize failure risks
- Personal and prompt handling of your time-critical repair requirements
- Tailored repairs combining highest levels of quality and care

#### Application-specific retrofitting

- Professional retrofitting of mechanical drive systems
- Reliable compatibility testing of existing solutions

Find out more about  
the WITTENSTEIN  
Service Portal



# WITTENSTEIN sizing tools



Our software portfolio helps you to make the perfect drive choice

You can easily download dimension sheets and CAD data, quickly select the ideal gearbox and design complex kinematic sequences down to the very last detail – our software solutions offer various methods for selecting the best, most reliable drive on all axes.



## CAD Point

– Your smart catalog

- Performance data, dimension sheets and CAD data for all gearboxes
- Comprehensive documentation for your selection
- Available online, no login required

[www.wittenstein-cad-point.de](http://www.wittenstein-cad-point.de)

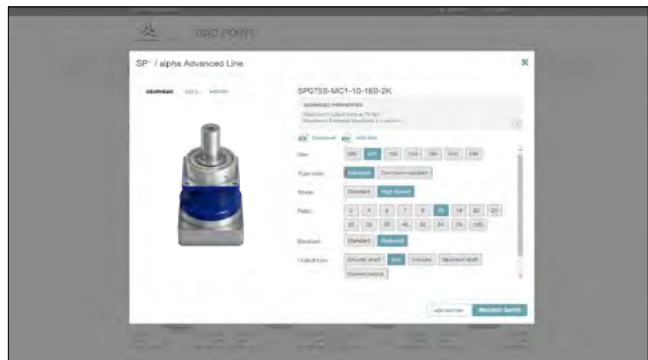

## cymex® select

– Ideal solutions within seconds

- Efficient and customizable product selection in seconds
- Top three product recommendations for your requirements
- Innovative calculation logic based on performance and price
- Available online, no login required
- Quick and direct quotation requests

[cymex-select.wittenstein-group.com](http://cymex-select.wittenstein-group.com)

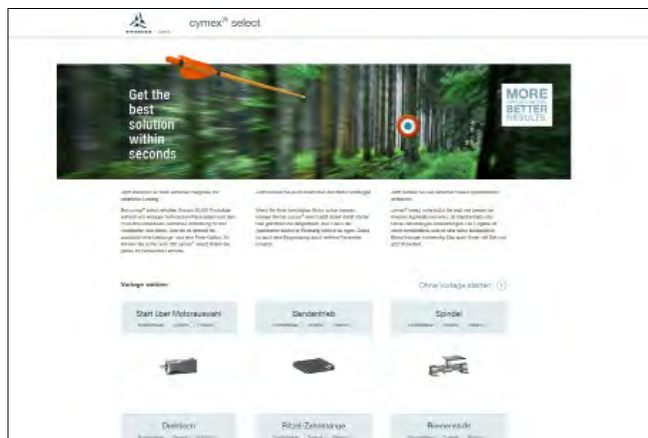

## cymex®5

– Calculate on the best

- Detailed calculation of complete drive trains
- Precise simulation of motion and load variables
- Downloadable software for complex designs

[www.wittenstein-cymex.de](http://www.wittenstein-cymex.de)





# WITTENSTEIN Service Portal



The web-based WITTENSTEIN Service Portal supports you throughout the entire life cycle of your WITTENSTEIN product – from installation and commissioning to servicing and/or drive replacement. Here you will find relevant and up-to-date information about your product including explanations, technical data, tutorial videos on assembly and commissioning, documentation, firmware files and the necessary contact details for support. The WITTENSTEIN Service Portal also makes it quick and easy to request replacement products and register returns for inspection or repair.

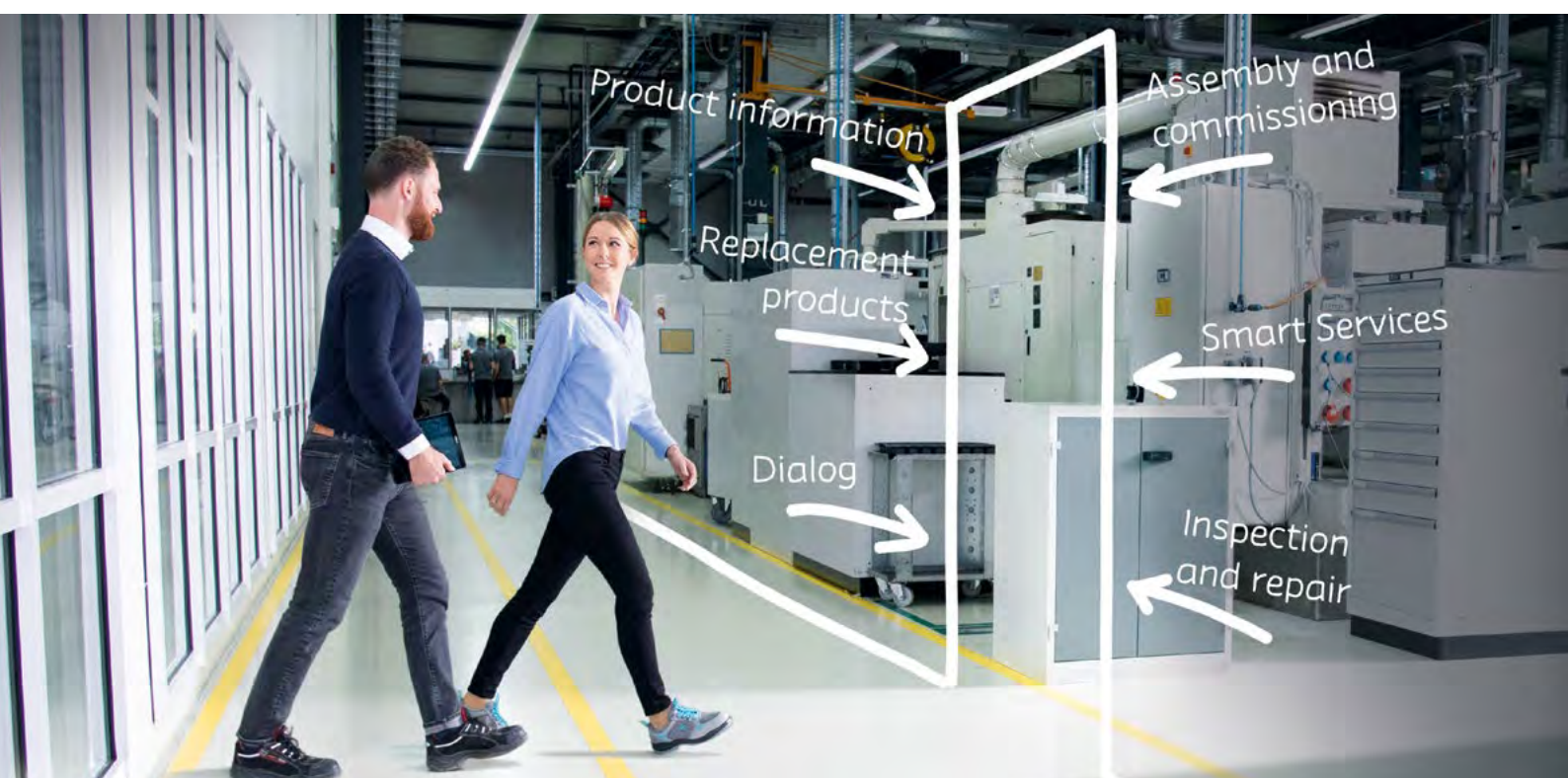

## Fast

You will receive clear information about your product without any need to wait or conduct extensive research.

## Simple access

You can access the WITTENSTEIN Service Portal via a desktop PC or mobile device and benefit from the intuitive navigation.

## Up to date

You can rest assured that all data, documentation and software is always up to date.

## Personal

For further support, you can get in touch directly with the relevant contact person.

## Traceable

You can access both the delivered version of the firmware and the latest version.

## International

The Service Portal is available in six languages (EN, DE, ES, IT, FR, TR).



# cynapse® – the smart feature from WITTENSTEIN

Gearboxes with cynapse® functionality independently record operating data of machines as well as plants and communicate it in the IIoT. The cynapse® Sensor Cube measures the temperature and acceleration on three axes. The sensor values can be integrated directly into your infrastructure via the IO-Link interface.

In addition, the Sensor Cube features an integrated storage and computing unit, which enables pre-processing of the data.

The Smart Services expand the functional scope of the cynapse® feature. The basic functions comprise data processing, visualization and analysis. The specific expertise, which WITTENSTEIN has gathered over more than 40 years of developing low-backlash planetary gearboxes, is used in combination with the operating data to establish and display the status of the gearbox in the Smart Services. Ultimately, the added value that you gain from using cynapse® and the Smart Services is what makes the difference. By means of condition monitoring and predictive maintenance, deviations in your machine are detected at an advanced stage, thereby preventing failures and downtimes.



Find out more  
about cynapse®



White paper on  
“Smart drive systems  
and services”



## Tailored digitalization of drive trains with graduated Smart Services

With the WITTENSTEIN Smart Services, machine manufacturers and operators can exploit the maximum potential offered by Industry 4.0 in drive trains. They can gradually tap into the performance offered by the individual services.



### cynapse® Connect

The Smart Service “cynapse® Connect” enables integration and routing of data, which is a fundamental prerequisite for condition monitoring, for instance. The Smart Service makes the recorded data available in a structured format. It can obtain this data from various source systems via IO-Link or OPC UA and utilize it for digital services from WITTENSTEIN. “cynapse® Connect” thus greatly simplifies the integration of smart gearboxes into the relevant machine infrastructure.



### cynapse® Monitor

Building upon the Smart Service “cynapse® Connect”, the Smart Service “cynapse® Monitor” enables straightforward evaluation and visualization of operating data. Since manufacturers and operators do not have to develop their own solutions, development requirements are massively reduced. In addition, the data of the “cynapse® Monitor” service can be used to monitor threshold values of selected parameters. Deviations and critical states in the behavior of gearboxes or in the relevant process can thus be identified at an early stage.



### cynapse® Analyze

“cynapse® Analyze” is an ever growing portfolio of smart features. A particular focus of this service is the detection of anomalies or wear. By way of example the Smart Service “Anomaly-Check” uses condition monitoring to detect tool wear on delta robots or changes in the belt tension of belt drives in packaging machines. In both cases, the cynapse® gearbox and these Smart Services allow the machine operators to take pre-emptive action in order to avoid damage events.

# Hygienically safe production

Consistent hygienic design for best possible process integration and reliable cleaning with new design freedom: We offer corrosion-resistant products and holistic solutions in a hygienic design based on our extensive expertise of drive solutions in hygienic systems.

Our portfolio for process-integrated application includes numerous variants ranging from planetary gearboxes to compact servo actuators.

As a member of EHEDG (European Hygienic Engineering & Design Group), we are pioneers in this field and develop our products in accordance with EHEDG guidelines. We enable our customers to always meet the highest demands with maximum efficiency with their machines.



HDV



AVF

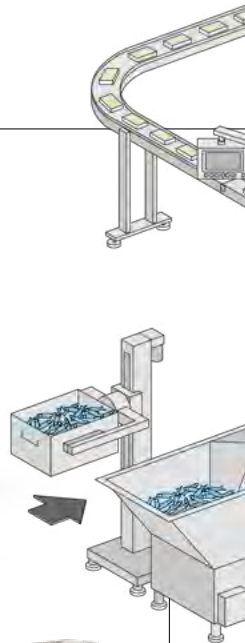

VT+ in corrosion-resistant design



Member of EHEDG

## Applications in the food industry



Fish processing



Filling and packaging dairy products



Portioning meat products

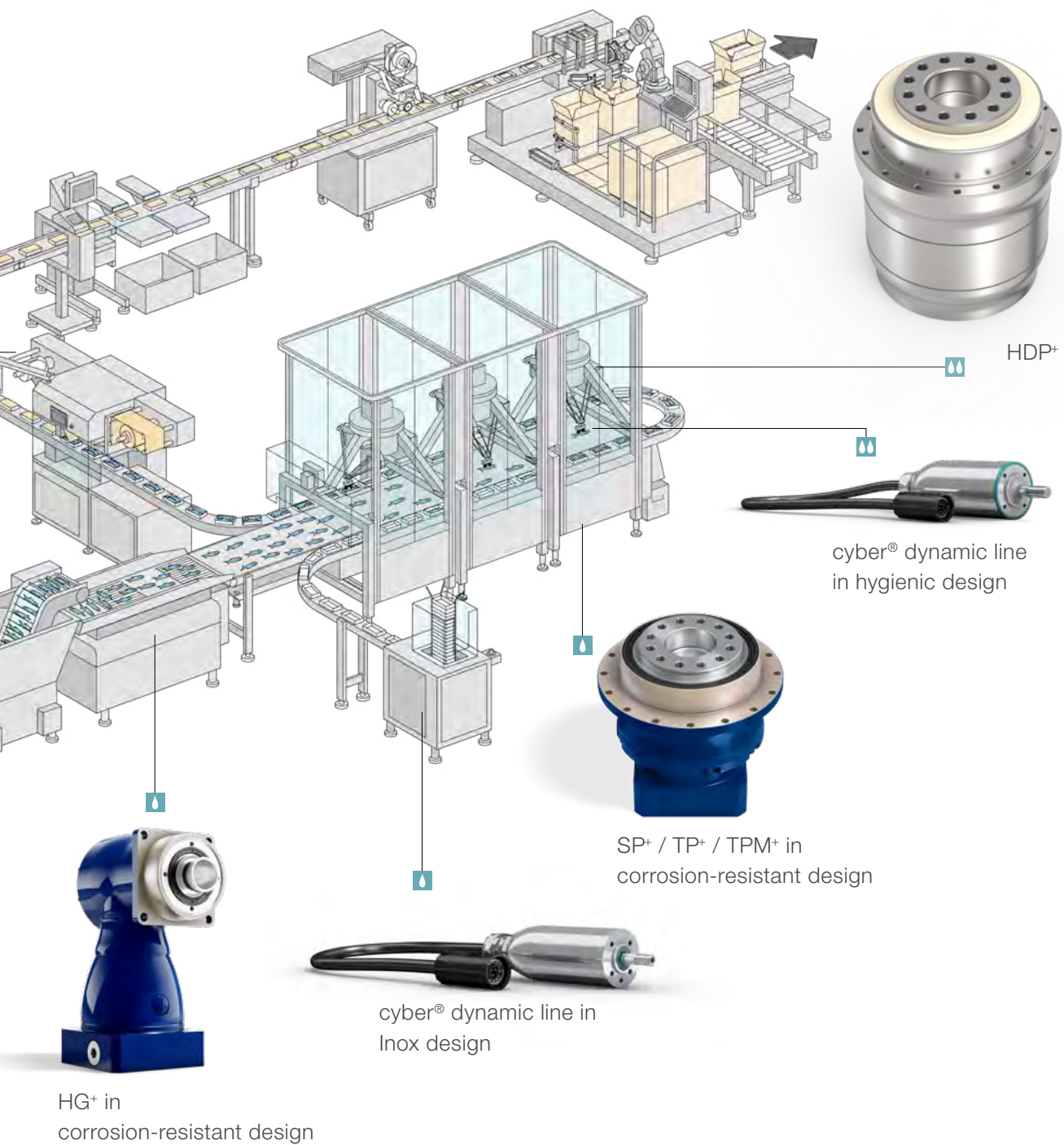

Application in wet and damp environments (spray area) – close to process



Applications in wet areas, including high-pressure cleaning as well as contact with cleaning agents and chemicals (food sector) – process-integrated

Find out more about hygienic design products



axenia in use: application at Provisur Technologies





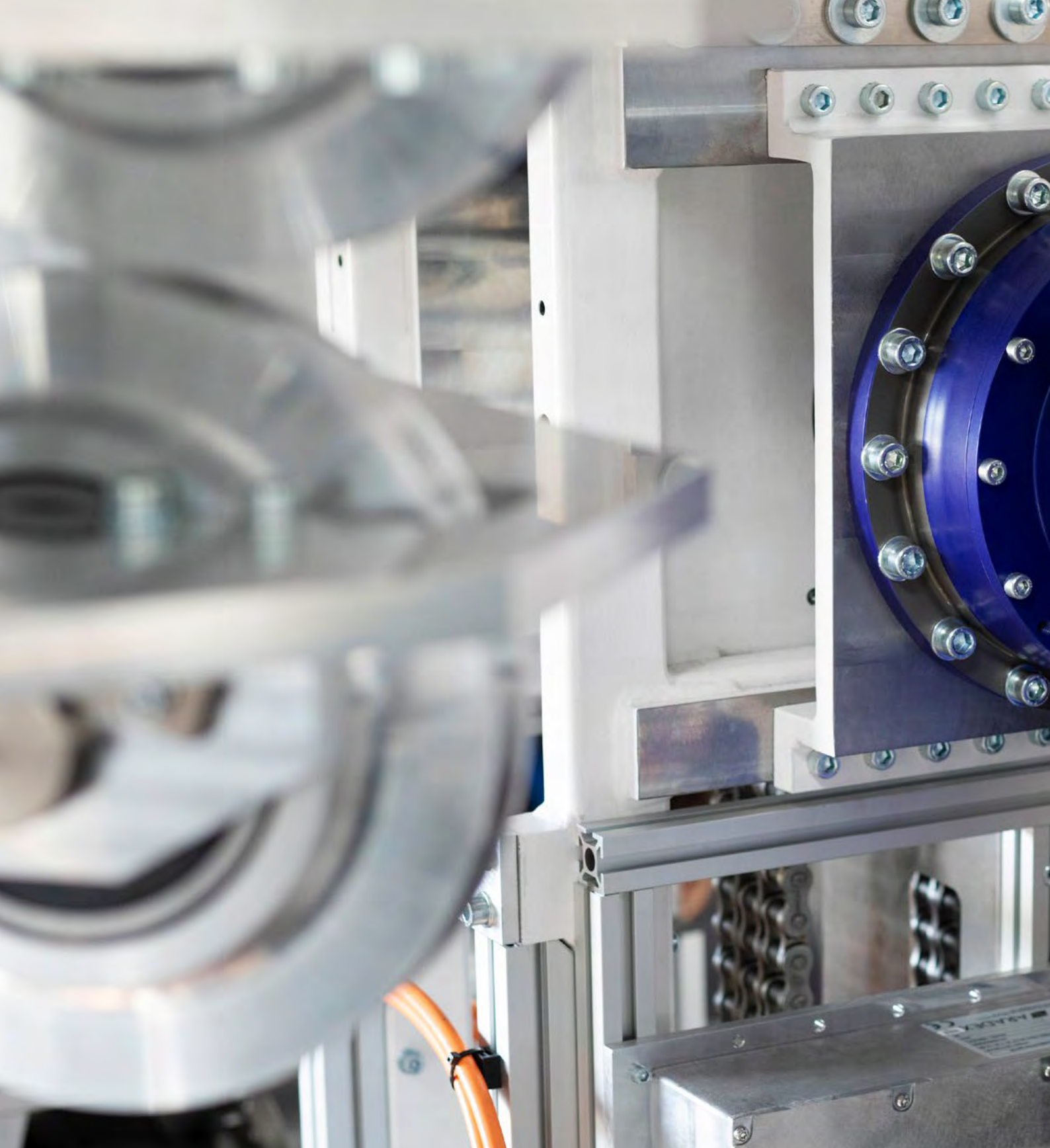

WITTENSTEIN alpha  
Company & portfolio



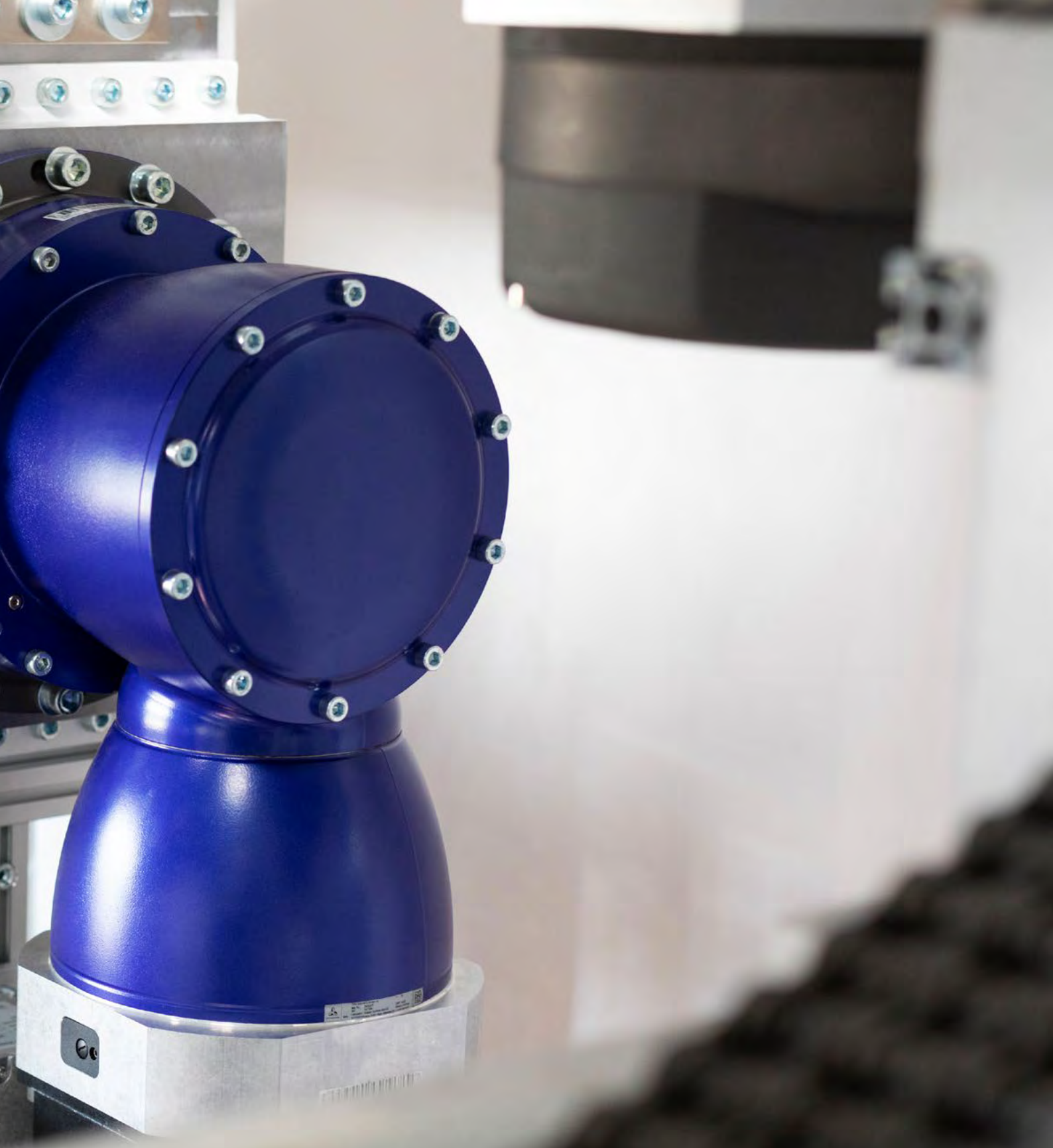

# WITTENSTEIN alpha

High-precision servo drives and linear systems

WITTENSTEIN alpha develops, produces and sells mechanical and mechatronic servo drive systems for sectors that require maximum precision. Our products continue to set new standards around the world.

We have divided our product portfolio into four segments in order to meet varying, application-specific requirements: While the Premium and Advanced segments focus on technology and performance, the Value and Basic segments place more emphasis on price and satisfying basic customer requirements.



## Smart Services with cynapse®



Collect. Analyze. Visualize.

Step into the digital world: Gearboxes with cynapse® record operating data independently. Combined with our Smart Services, we provide you with a simple way to analyze and process your machine data.

- cynapse® Connect
- cynapse® Monitor
- cynapse® Analyze

## Applications and uses

### JASA uses our servo gearboxes in its vertical packaging machines

Dutch company JASA Packaging Solutions stands for innovation, quality and flexibility in packaging technology. The vertical packaging machines from JASA, which are made entirely from stainless steel, can be used for a wide range of products and packaging in the food industry. They are fast, hygienic and flexible. Many of the machines use servo gearboxes from WITTENSTEIN, in particular hypoid and planetary gearboxes from the alpha Advanced Line and alpha Value Line.



*“I’ve never heard of us having to replace a faulty WITTENSTEIN gearbox anywhere.”*

Hendrik van den Berg  
R&D Director at JASA Packaging Solutions



### Dynamics and precision go hand in hand – our drive technology for press automation



The latest press linking system from Strothmann Machines & Handling sets new standards: The FeederPlus 6neo transports up to 16 formed blanks for vehicle bodies per minute – each weighing as much as 60 kg – highly dynamically and with millimeter precision from one press to the next. This outstanding performance is achieved thanks to gearboxes, servo actuators and rack and pinion systems made by WITTENSTEIN alpha. Their exceptional power density means they can handle high drive power and bearing forces even with their extremely compact design.

*“To see WITTENSTEIN simply as a component supplier would not do justice to the trusting partnership we have enjoyed for so many years.”*

Andreas Senge  
Product Group Manager for Press Automation and Handling at Strothmann



# WITTENSTEIN alpha on all axes

## Servo gearboxes

Maximum precision, dynamics and an above-average torque density are essential requirements of a reliable servo gearbox in practical application.

WITTENSTEIN alpha has servo gearboxes for every application and every performance range. Our low-backlash planetary gearboxes and right-angle gearboxes reflect our passion for innovation and maximum precision.

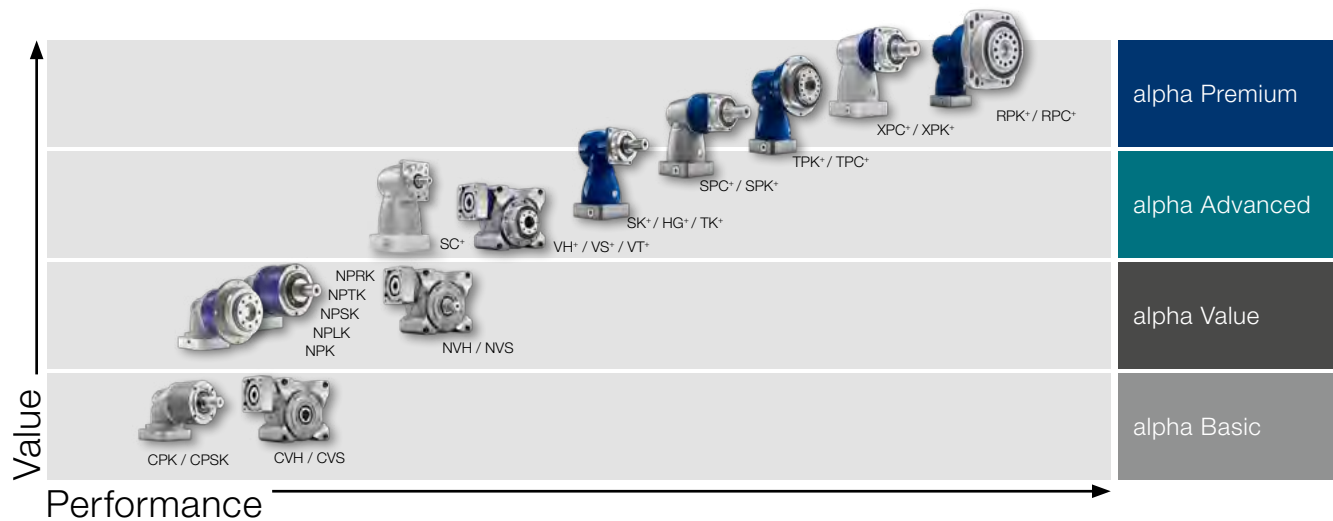
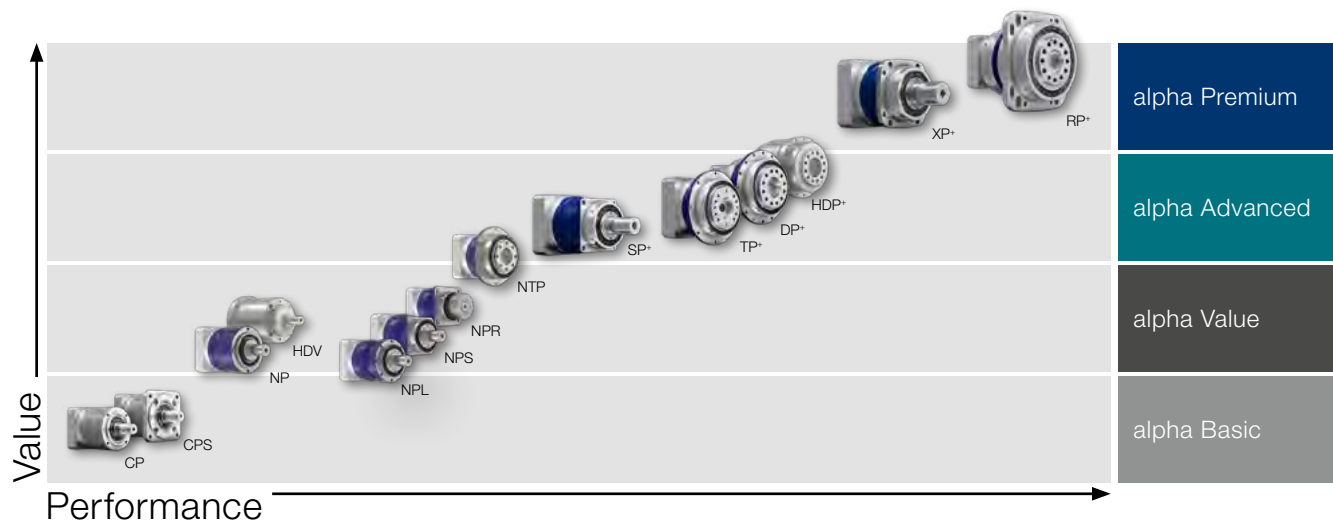



## Linear systems

Our specialist knowledge covers a broad range, from coupling linear-system components, gearboxes, motors, pinions and racks through to outstanding system solutions. In order to meet your specific

linear drive requirements in terms of smooth running, positioning accuracy and feed force, we offer linear systems that are optimally tailored to your application.

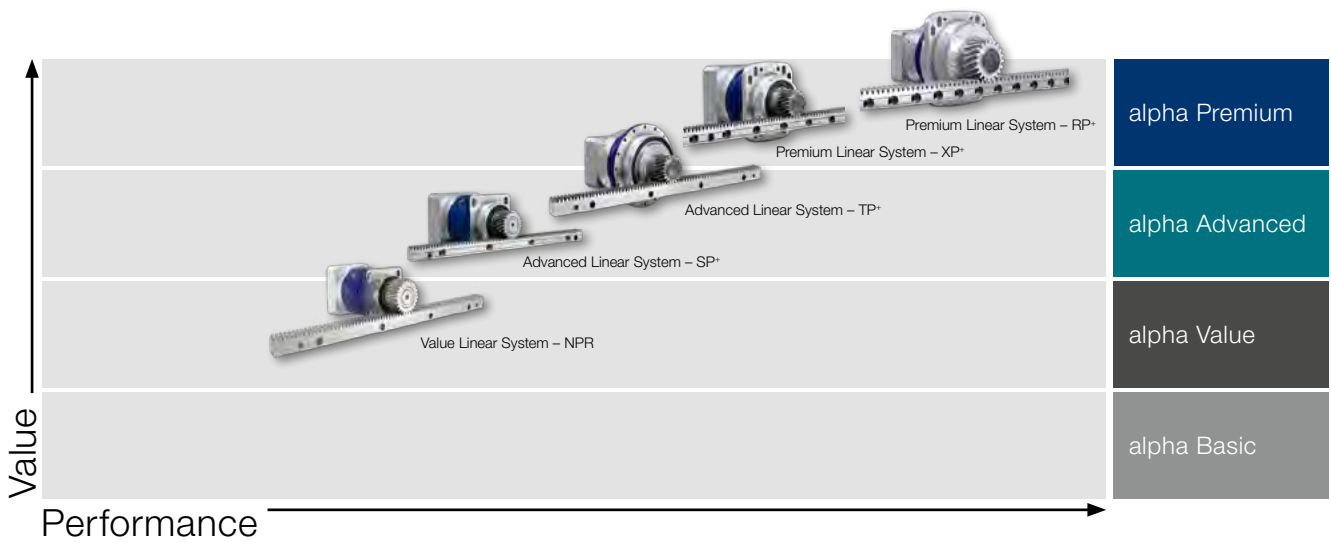

## Servo actuators

Our servo actuators are characterized by their high power density, low mass moment of inertia, high rigidity and low backlash. With these outstanding technical properties, the servo actuators can make

a significant contribution to increased productivity and reduced energy usage.

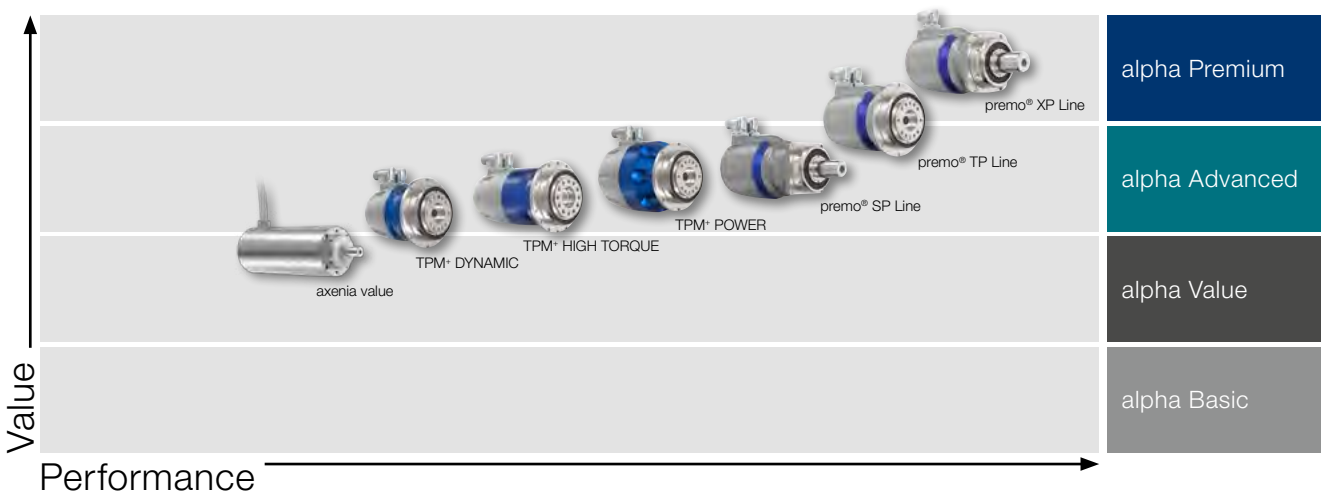



# Low-backlash planetary gearboxes



**CP**  
alpha Basic



- Ratio: 3-100
- Max. backlash:  $\leq 12$  arcmin
- Max. torque: 17-800 Nm
- Additional features:  
food-grade lubrication

**CPS**  
alpha Basic



- Ratio: 3-100
- Max. backlash:  $\leq 12$  arcmin
- Max. torque: 48-272 Nm
- Additional features:  
food-grade lubrication

**LPB+**  
alpha Value



- Ratio: 3-100
- Max. backlash:  $\leq 8$  arcmin
- Max. torque: 37-305 Nm
- Additional features:  
food-grade lubrication

**NPR**  
alpha Value



- Ratio: 3-100
- Max. backlash:  $\leq 8$  arcmin
- Max. torque: 51-800 Nm
- Additional features:  
flange with slotted holes (standard),  
food-grade lubrication

**NPT**  
alpha Value



- Ratio: 3-100
- Max. backlash:  $\leq 8$  arcmin
- Max. torque: 18-700 Nm
- Additional features:  
food-grade lubrication

**NTP**  
alpha Value

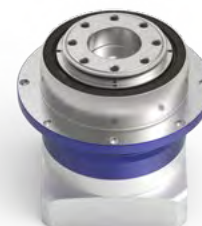

- Ratio: 4-100
- Max. backlash:  $\leq 5$  arcmin
- Max. torque: 56-800 Nm
- Additional features:  
food-grade lubrication



## NP alpha Value



- 
- Ratio: 3-100
  - Max. backlash:  $\leq 8$  arcmin
  - Max. torque: 18-800 Nm
  - Additional features:  
food-grade lubrication

## NPL alpha Value



- 
- Ratio: 3-100
  - Max. backlash:  $\leq 8$  arcmin
  - Max. torque: 51-800 Nm
  - Additional features:  
food-grade lubrication

## NPS alpha Value



- 
- Ratio: 3-100
  - Max. backlash:  $\leq 8$  arcmin
  - Max. torque: 51-800 Nm
  - Additional features:  
flange with slotted holes (standard),  
food-grade lubrication

## HDV alpha Value



- 
- Ratio: 4-100
  - Max. backlash:  $\leq 10$  arcmin
  - Max. torque: 46-320 Nm
  - Additional features:  
food-grade lubrication,  
corrosion-resistant

# Low-backlash planetary gearboxes



**SP+**  
alpha Advanced



- Ratio: 3-100
- Max. backlash:  $\leq 1$  arcmin
- Max. torque: 48-5700 Nm
- Additional features:  
flange with slotted holes,  
ATEX (2014/34/EU), food-grade  
lubrication, corrosion-resistant,  
optimized mass inertia

**TP+**  
alpha Advanced



- Ratio: 4-302.5
- Max. backlash:  $\leq 1$  arcmin
- Max. torque: 43-22,000 Nm
- Additional features:  
food-grade lubrication,  
corrosion-resistant,  
optimized mass inertia

**HDP+**  
alpha Advanced



- Ratio: 22-55
- Max. backlash:  $\leq 1$  arcmin
- Max. torque: 252-1121 Nm
- Additional features:  
food-grade lubrication,  
corrosion-resistant,  
optimized mass inertia

**DP+**  
alpha Advanced



- Ratio: 16-55
- Max. backlash:  $\leq 1$  arcmin
- Max. torque: 50-1402 Nm
- Additional features:  
food-grade lubrication,  
corrosion-resistant,  
optimized mass inertia

**XP+**  
alpha Premium



- Ratio: 3-100
- Max. backlash:  $\leq 1$  arcmin
- Max. torque: 56-4400 Nm
- Additional features:  
flange with slotted holes, food-  
grade lubrication, optimized mass  
inertia

**RP+**  
alpha Premium



- Ratio: 4-220
- Max. backlash:  $\leq 1$  arcmin
- Max. torque: 352-10,450 Nm
- Additional features:  
flange with slotted holes (standard),  
food-grade lubrication,  
optimized mass inertia

# UpGreat!

## NTP – Qualified for more Value

The NTP planetary gearbox with output flange uses the familiar output geometry of the TP+ gearbox. The reinforced roller bearings on the output allow very high external forces. Coupled with the new tothing and the backlash of  $\leq 5$  arcmin, the NTP offers unique performance parameters for this product segment.

Thanks to a wide range of ratios, the NTP planetary gearbox is suitable for the most diverse applications.

### Improved repeat accuracy

With backlash  $\leq 5$  arcmin, the new tothing class of the product allows it to be used in applications requiring increased levels of precision.

### Greater absorption of external forces

The use of more powerful roller bearings allows the NTP to absorb significantly higher external forces.

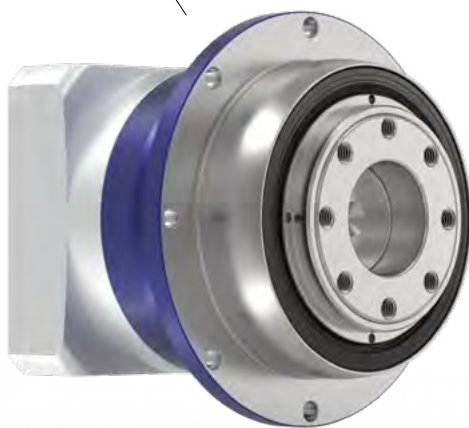

### Better synchronization

The new, high-quality tothing components with revised microgeometry improve the synchronization properties of the NTP.

### Reduced operating noise

As well as offering improved synchronization, the optimized tothing also has a positive impact on the operating noise of the NTP.

### Efficiency on all axes

The alpha Value Line is suitable for universal application and offers the best, most economical solution for virtually all requirements – on every axis and for all industries.

Find out more about  
the NTP





# Right-angle gearboxes



**CPK**  
alpha Basic



- Ratio: 3-100
- Max. backlash:  $\leq 15$  arcmin
- Max. torque: 14-700 Nm
- Additional features:  
food-grade lubrication

**CPSK**  
alpha Basic



- Ratio: 3-100
- Max. backlash:  $\leq 15$  arcmin
- Max. torque: 33-272 Nm
- Additional features:  
food-grade lubrication

**NPK**  
alpha Value



- Ratio: 3-100
- Max. backlash:  $\leq 11$  arcmin
- Max. torque: 14-700 Nm
- Additional features:  
food-grade lubrication

**SC+**  
alpha Advanced



- Ratio: 1-2
- Max. backlash:  $\leq 4$  arcmin
- Max. torque: 12-378 Nm
- Additional features:  
food-grade lubrication

**SPC+**  
alpha Advanced



- Ratio: 4-20
- Max. backlash:  $\leq 2$  arcmin
- Max. torque: 48-1936 Nm
- Additional features:  
food-grade lubrication

**TPC+**  
alpha Advanced



- Ratio: 4-20
- Max. backlash:  $\leq 2$  arcmin
- Max. torque: 48-2560 Nm
- Additional features:  
food-grade lubrication



### NPLK alpha Value

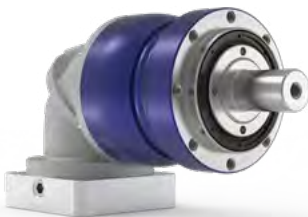

- Ratio: 3-100
- Max. backlash:  $\leq 11$  arcmin
- Max. torque: 33-700 Nm
- Additional features:  
food-grade lubrication

### NPSK/NPRK alpha Value



- Ratio: 3-100
- Max. backlash:  $\leq 11$  arcmin
- Max. torque: 33-700 Nm
- Additional features:  
food-grade lubrication

### NPTK alpha Value



- Ratio: 3-100
- Max. backlash:  $\leq 11$  arcmin
- Max. torque: 14-700 Nm
- Additional features:  
food-grade lubrication

### SK+ / HG+ / TK+ alpha Advanced



- Ratio: 3-100
- Max. backlash:  $\leq 4$  arcmin
- Max. torque: 20-768 Nm
- Additional features:  
ATEX (2014/34/EU),  
food-grade lubrication,  
corrosion-resistant

### SPK+ alpha Advanced



- Ratio: 12-1000
- Max. backlash:  $\leq 2$  arcmin
- Max. torque: 80-5700 Nm
- Additional features:  
food-grade lubrication,  
corrosion-resistant

### TPK+ alpha Advanced



- Ratio: 12-5500
- Max. backlash:  $\leq 1.3$  arcmin
- Max. torque: 80-10,450 Nm
- Additional features:  
food-grade lubrication,  
corrosion-resistant

# Right-angle gearboxes



**XPC+**  
alpha Premium



- Ratio: 4-20
- Max. backlash:  $\leq 2$  arcmin
- Max. torque: 48-2646 Nm
- Additional features:  
flange with slotted holes,  
food-grade lubrication

**XPK+**  
alpha Premium



- Ratio: 12-1000
- Max. backlash:  $\leq 2$  arcmin
- Max. torque: 40-2520 Nm
- Additional features:  
flange with slotted holes,  
food-grade lubrication

**RPC+**  
alpha Premium



- Ratio: 22-55
- Max. backlash:  $\leq 1.3$  arcmin
- Max. torque: 1402-7535 Nm
- Additional features:  
flange with slotted holes (standard),  
food-grade lubrication

**RPK+**  
alpha Premium



- Ratio: 48-5500
- Max. backlash:  $\leq 1.3$  arcmin
- Max. torque: 1100-10,450 Nm
- Additional features:  
flange with slotted holes (standard),  
food-grade lubrication

# Worm gearboxes



## CVH / CVS alpha Basic



- Ratio: 7-40
- Max. backlash:  $\leq 15$  arcmin
- Max. torque: 68-301 Nm
- Additional features:  
food-grade lubrication

## NVH / NVS alpha Value



- Ratio: 4-400
- Max. backlash:  $\leq 6$  arcmin
- Max. torque: 74-365 Nm
- Additional features:  
food-grade lubrication,  
corrosion-resistant

## VT+ alpha Advanced



- Ratio: 4-400
- Max. backlash:  $\leq 2$  arcmin
- Max. torque: 165-1505 Nm
- Additional features:  
food-grade lubrication,  
corrosion-resistant

## VS+ alpha Advanced



- Ratio: 4-400
- Max. backlash:  $\leq 2$  arcmin
- Max. torque: 165-1505 Nm
- Additional features:  
food-grade lubrication,  
corrosion-resistant

## VH+ alpha Advanced



- Ratio: 4-400
- Max. backlash:  $\leq 2$  arcmin
- Max. torque: 74-1505 Nm
- Additional features:  
food-grade lubrication,  
corrosion-resistant



# Linear systems



## Value Linear Systems alpha Value



- Adapted to linear applications with comparatively low demands in terms of smooth running, positioning accuracy and feed force

## Advanced Linear Systems alpha Advanced



- Adapted to linear applications with moderate to high demands in terms of smooth running, positioning accuracy and feed force
- Available with the innovative INIRA® rack installation

## Premium Linear Systems alpha Premium



- Adapted specifically to applications with extremely high demands in terms of smooth running, positioning accuracy and feed force
- Available with the innovative INIRA® rack installation

## Lubrication system



- Ready-to-install solutions for centralized and decentralized lubrication of open tothing and linear guides
- Durable lubrication pinions for continuous lubricant supply
- Distribution systems for implementing complete lubrication solutions

## Racks



- Different versions available
- Tailored to the Value, Advanced and Premium Linear Systems
- Revolutionary INIRA® installation method

## Pinions



- Pinion optimally tailored to the gearbox and racks
- Wide range available
- Factory-fitted pinions available

# WITTENSTEIN alpha on all axes – now with 2 meter racks

We offer complete drive solutions for any axis from a single source – with gearboxes, pinions and racks. To meet the needs of customers even better, we have expanded our portfolio in the Value and Advanced segment by adding racks with a length of up to 2 m. Depending on the application, you can now choose between 2 x 1 m and 1 x 2 m versions.

We would be happy to help you choose the optimum rack for your application!



## Our new 2 meter racks

- Quick and efficient installation without transition in short axes
- Optionally with INIRA® clamping, pinning and adjusting
- Easy handling with short machine beds
- High feed forces

Example applications:

- Y axes in laser cutting machines
- Lifting axes in gantry robots
- Plasma and water jet cutting machines
- Telescopic axes, e.g. in Cartesian robots
- Tool changers
- 7th axis in robotics
- Existing axes with 2 m racks in use

## Our proven 1 meter racks

- Quick and efficient installation with INIRA® clamping, adjusting and pinning
- Easy transport, storage (standardization) and handling
- Improved axis accuracy thanks to higher rack segment precision – precise adjustment of the rack transition with INIRA® adjusting
- Highest feed forces with case-hardened racks (downsizing potential)

Find out more about  
alpha Linear Systems



# Servo actuators



## premo® SP Line alpha Advanced



- Ratio: 16-100
- Max. backlash:  $\leq 3$  arcmin
- Max. torque: 32-315 Nm
- Additional features:  
food-grade lubrication

## premo® TP Line alpha Advanced



- Ratio: 16-100
- Max. backlash:  $\leq 1$  arcmin
- Max. torque: 35-380 Nm
- Additional features:  
food-grade lubrication

## premo® XP Line alpha Premium



- Ratio: 16-100
- Max. backlash:  $\leq 2$  arcmin
- Max. torque: 35-450 Nm
- Additional features:  
flange with slotted holes,  
food-grade lubrication

## TPM+ DYNAMIC alpha Advanced



- Ratio: 16-91
- Max. backlash:  $\leq 1$  arcmin
- Max. torque: 30-1300 Nm
- Additional features:  
food-grade lubrication,  
corrosion-resistant

## TPM+ HIGH TORQUE alpha Advanced



- Ratio: 22-220
- Max. backlash:  $\leq 1$  arcmin
- Max. torque: 230-950 Nm
- Additional features:  
food-grade lubrication,  
corrosion-resistant

## TPM+ POWER alpha Advanced



- Ratio: 4-100
- Max. backlash:  $\leq 1$  arcmin
- Max. torque: 15-750 Nm
- Additional features:  
food-grade lubrication,  
corrosion-resistant

# precision meets motion

## premo<sup>®</sup> – rotary servo actuators

### Absolute precision meets perfect motion:

The key idea behind the first fully scalable servo-actuator platform from WITTENSTEIN is uncompromising flexibility from the point of view of the user. Motors and gearboxes with performance features graded according to the application can be configured modularly to individual servo actuators. The result is a modular system for a broad range of applications that is significantly more versatile and more individual with regard to performance and meets virtually all drive technology, integration and industry specification requirements.

#### Encoder

- Resolver (standard version)
- Encoder (optional) with EnDat 2.1, EnDat 2.2, HIPERFACE<sup>®</sup>, HIPERFACE DSL<sup>®</sup>, DRIVE-CLiQ

#### Electrical connection

- Straight or right-angled version
- Single-cable connection for DSL protocol and EnDat 2.2

#### Pin assignment

Special pin assignments for power and signal

Temperature sensor PTC/PT1000

#### Holding brake

Suitable permanent magnet holding brake

#### Operating voltage:

320 and 560 V<sub>DC</sub>

#### Lubrication

- Standard lubrication (oil or grease)
- Food-grade grease and oil

#### Backlash

Reduced backlash (optional)

#### Gearbox model

Different shapes for the output and housing flange



Find out more about  
premo<sup>®</sup>







# WITTENSTEIN cyber motor Company & portfolio





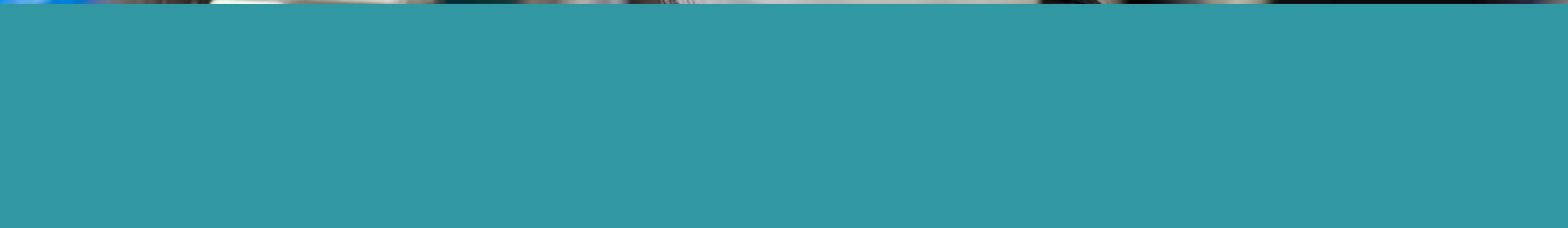

# WITTENSTEIN cyber motor

Highly dynamic servo motors and drive electronics

WITTENSTEIN cyber motor develops, produces and sells technologically advanced servo motors with sophisticated drive electronics as well as complete mechatronic drive systems with maximum power density. Our particular expertise lies in specialized motors for ultra-high vacuums, radioactive environments and high temperatures.

We collaborate closely with our customers on individual projects. During the development process, we share knowledge, learn from one another and develop new ideas together. The resulting solutions help differentiate our customers from their competitors.



New servo drive system for AGVs and AMRs impresses with industrial simplicity

Makes everything simple.

cyber® iTAS® system 2 – the drive system for AGVs.

Safety

Performance

Connectivity

Flat design

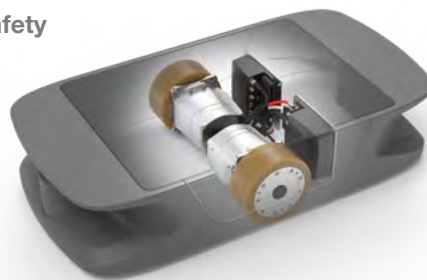

The cyber® iTAS® system 2, consisting of a servo drive and actuator, combines a lean and integration-friendly safety architecture with maximum power density. This gives the AGVs (Automated Guided Vehicles) and AMRs (Autonomous Mobile Robots) a decisive gain in performance and increases productivity. The system design of the differential drive system with an integrated brake and wheel also impresses with its industrial simplicity, which minimizes commissioning

and service requirements in the long term. Benefit from all these advantages in the development of AGVs and other mobile platforms with vehicle weights between 1 and 3 t.

More Information about cyber® iTAS® system 2



# WITTENSTEIN cyber motor

Applications and uses

Our small servo drive systems dose liquids precisely

It was a complex challenge: Liquids of varying viscosity needed to be dosed into pads efficiently and precisely in a dishwasher pad forming machine at Harro Höfliger GmbH – up to six million times a day. Harro Höfliger’s developers put their trust in small servo drive systems from WITTENSTEIN cyber motor, which are made from 100% stainless steel and hence resistant to corrosion. The compact, lightweight design also impressed the customer thanks to the significant space savings. The fact that the motor and the servo drive are supplied from a single source guarantees technically optimal solutions at all times with no interface risks.



*“Repeatable dosing precision is enormously important, both in the interests of a reliable process and to ensure uniform product quality.”*

Hubert Rypalla  
Project Manager at Harro Höfliger



Two process steps in one – our frameless servo motors make it possible



Screwing and sealing of closures in a single work step, while being fully hygienic and offering better protection against recontamination of products and higher process reliability – these are the benefits of the new InduTwist induction sealer from IMAGINE Engineering. This innovative screw cap applicator is equipped with compact and highly dynamic frameless servo motors from the cyber® kit line developed by WITTENSTEIN cyber motor.

*“For the new screw cap applicator, we chose the frameless servo motors of the cyber®kit line due to their function as compact, highly dynamic motors.”*

Dipl.-Ing Klaus Baltés  
Managing Director IMAGINE Engineering GmbH





# Servo motors & actuators

Servo solutions



## cyber® dynamic motor



- Rotative synchronous motors
- Size: 17-40 mm
- DC bus voltage: 48 V<sub>DC</sub>
- Max. torque: 0.035-21 Nm
- Max. speed: 5000-21,000 rpm
- Optional: absolute encoder, brake, planetary gearbox or 100% stainless steel design

## cyber® dynamic actuator R



- Rotative servo actuators
- Size: 17-40 mm
- DC bus voltage: 48 V<sub>DC</sub>
- Max. torque: 0.1-22 Nm
- Max. speed: 56-2500 rpm
- Optional: absolute encoder, brake, 100% stainless steel design

## cyber® dynamic actuator L



- Linear actuators
- Size: 17-40 mm
- DC bus voltage: 48 V<sub>DC</sub>
- Max. force: 200-2000 N
- Max. linear velocity: 300-900 mm/s
- Optional: stroke lengths, 100% stainless steel design, encoder interfaces, holding brake

## cyber® kit line small



- Rotative synchronous motors (frameless)
- Size: 50-85 mm
- DC bus voltage: 48 V<sub>DC</sub> and 560 V<sub>DC</sub>
- Max. torque: 1-30 Nm
- Max. speed: up to 10,000 rpm

## cyber® kit line medium



- Rotative synchronous motors (frameless)
- Size: 100-112 mm
- DC bus voltage: 48 V<sub>DC</sub> and 560 V<sub>DC</sub>
- Max. torque: 16-90 Nm
- Max. speed: up to 3600 rpm

## cyber® kit line large



- Rotative synchronous motors (frameless)
- Size: 290-530 mm
- DC bus voltage: 560 V<sub>DC</sub>
- Max. torque: 580-9000 Nm
- Max. speed: up to 250 rpm



# Servo motors & actuators

Customized servo solutions



## cyber® power motor



- Rotative synchronous motors
- Size: 19-440 mm
- Max. torque: 0.02-1000 Nm
- Max. speed: 4000-25,000 rpm
- Optional: holding brake, hollow shaft, liquid cooling

## cyber® force actuator



- Linear actuators
- Size: 40-270 mm
- Max. force: 0.5-750 kN
- Max. linear velocity: 290-2300 mm/s
- Optional: screw type, hollow shaft, guidance with anti-rotation

## cyber® linear motor



- Linear synchronous motors
- Max. force: 100 N
- Max. linear velocity: 5 m/s
- Max. acceleration: 500 m/s<sup>2</sup>
- Optional: linear guidance, encoder

## cyber® torque motor



- Rotative synchronous motors
- Size: 50-540 mm
- Max. torque: 0.02-1700 Nm
- Max. speed: 0-4000 rpm
- Optional: holding brake, hollow shaft, liquid cooling

## cyber® kit motor



- Rotative synchronous motors (frameless)
- Size: 19-440 mm
- Max. torque: 0.02-1700 Nm
- Max. speed: 2000-25,000 rpm
- Optional: winding adjustment, Hall sensor

### Note:

The images and technical data shown are examples of customized servo solutions.

We will be happy to develop a solution for you that is tailored to your drive task. Take advantage of our wealth of experience, our highly skilled staff and our comprehensive services.

Contact us:

[info@wittenstein-cyber-motor.de](mailto:info@wittenstein-cyber-motor.de)



# Special motors

Customized servo solutions



## cyber® cleanroom motor



- Motors for cleanroom environments
- Use in cleanrooms up to class ISO1
- Maximum particle purity
- Optional: gearbox, holding brake

## cyber® hygienic motor



- Hygienic motors
- Optimal sealing properties: up to IP69X
- Direct contact with food allowed
- Optional: gearbox, holding brake

## cyber® ex motor



- Explosion-proof motors
- Explosive zones 1 & 2
- Up to temperature class T4: 135°C
- Optional: gearbox, holding brake

## cyber® vacuum motor



- Motors for vacuum environments
- Pressure: up to  $10^{-9}$  mbar
- Ambient temperatures: up to 200°C
- Optional: gearbox, holding brake

## cyber® radhard motor



- Motors for radiation environments
- Radiation levels up to 5 MGy
- Ambient temperatures: up to 200°C
- Optional: gearbox, holding brake

## cyber® hightemp motor



- High-temperature motors
- Ambient temperatures: up to 260°C
- Pressure: up to 2100 bar
- Optional: gearbox, pump, linear actuator

**Note:** The images and technical data shown are examples of customized servo solutions.

# Customized drives



WITTENSTEIN cyber motor GmbH develops drives that are tailor-made to specific customer requirements. This enables our customers to differentiate themselves from the competition and maximize their individual benefits.

## Individual drive configuration

- Frameless motors
- Complete drive
- Linear actuator
- System/module

## Individual performance data

- High speed
- High torque
- High dynamic
- High efficiency

## Individual adaptation to environmental conditions

- High and low temperatures
- Hygienic design
- Explosion-proof
- Radiation-resistant
- Vacuum-compatible

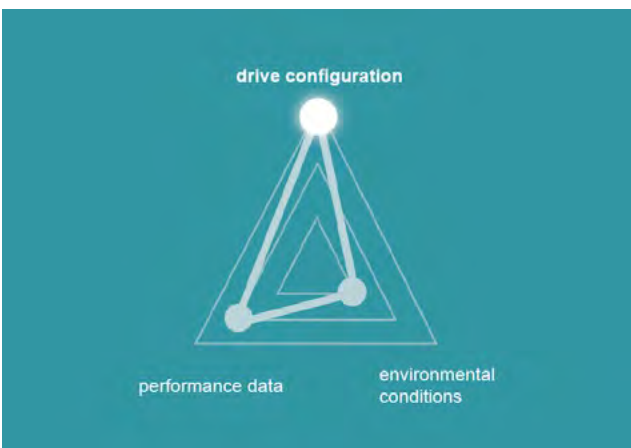

When designing new plant and machinery or retrofitting existing equipment, special requirements often have to be met in terms of performance, installation space or environmental conditions. Thanks to a high level of vertical integration, WITTENSTEIN cyber motor provides numerous options for individual adaptation. All specifications are realized in close cooperation with the customer, leading to a drive that is optimally tailored to each client's application.

## Really customized



## instead of customized

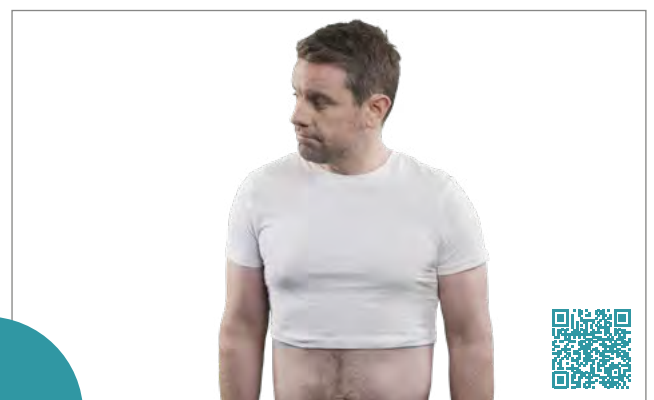

# Servo drives

Servo solutions



## cyber® simco® drive 2



- Supply voltage: 12-60 V<sub>DC</sub>
- Max. current: 15-200 A<sub>eff</sub>
- Max. power: 750-10.000 W
- Protection class: IP20/IP65

## cyber® simco® drive 1



- Supply voltage: 12-60 V<sub>DC</sub>
- Max. current: 100 A<sub>eff</sub>
- Max. power: 5000 W
- Protection class: IP20

## Customized servo solutions

### cyber® power drive



- Supply voltage: 100-800 V<sub>DC</sub>
- Max. current: 300-500 A<sub>eff</sub>
- Max. power: 150-250 kVA

# Servo systems

Servo solutions



## cyber® dynamic system



- Size: 40 mm (motor)
- DC bus voltage: 12-60 V<sub>DC</sub>
- Max. torque: 1-22 Nm
- Max. speed: up to 5000 rpm
- Optional: absolute encoder (singleturn & multiturn) and gearbox or ball screw

## cyber® iTAS® system 2



- Size: 085
- DC bus voltage: 48 V<sub>DC</sub>
- Max. torque: 200 Nm
- Nominal speed: up to 2.5 m/s
- Integrated: safety encoder, brake, wheel

## cyber® iTAS® system

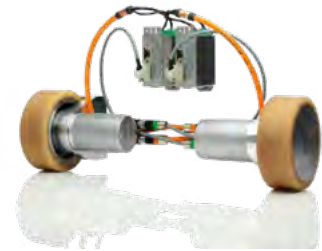

- Size: 004-050
- DC bus voltage: 24-48 V<sub>DC</sub>
- Max. feed force: 380-5200 N
- Nominal speed: up to 2.6 m/s
- Optional: dynamic brake, additional encoder for speed control, wheel

# Accessories for drive systems

## cyber® power supply



- Version: single-phase and three-phase power supplies
- Input: AC 100-240 V / AC 380-480 V
- Output: 24-48 V DC
- Power: 120-960 W

## cyber® distribution box



- Supply voltage: 12-60 V<sub>DC</sub>
- Input power supply: 1 (max. current: 45 A)
- Outputs power supply: 6 (max. current: 30 A)
- Inputs/outputs fieldbus interface: 2/2 (Ethernet)





WITTENSTEIN galaxie  
Company & portfolio



# WITTENSTEIN galaxie

Superior gearboxes and drive systems

WITTENSTEIN galaxie develops, produces and sells disruptively innovative gearboxes and drive systems, whose functional superiority is based on an entirely new operating principle. Our unique expertise makes us the global leader in rotary mechatronic drive technologies.

Our innovations enable our customers to implement their machines and systems with previously unattainable performance parameters. This allows them to enhance their market position in the long term. Moreover, our solutions help products to be manufactured in an efficient way that conserves resources.



## Galaxie® gearboxes with new accuracy line

WITTENSTEIN galaxie GmbH is offering a new Galaxie® gearbox series in the form of the accuracy line. The kinematics, bearings, ratios and sizes are tailored to the exact requirements of high-precision applications. The Galaxie® accuracy line comprises three product versions: flange

gearboxes, hollow-shaft gearboxes and customized servo actuators. The series, which includes two miniaturized versions, is available in four sizes and is designed for maximum torques of 150 to 6000 Nm.

Galaxie® robustness line		Galaxie® accuracy line	
Galaxie® GS	Galaxie® D	miniaturized Galaxie®	Galaxie® GS
Galaxie® GH	Galaxie® G	Galaxie® D	Galaxie® G



The combination of the technical properties of the disruptive Galaxie® technology – backlash-free operation, no maintenance requirements, torsional rigidity and torque density – results in our award-winning gearbox system.



# WITTENSTEIN galaxie

Applications and uses

## Performance boost in INDEX ABC turning machine

In terms of the machine concept, working area, footprint, part times and machining quality, the newly enhanced Index ABC offers all the familiar characteristics of its predecessor – more than 3000 of which have been delivered to customers. One revolutionary aspect, however, is the new upper revolver. Based on the Galaxie® gearbox GS 190 from WITTENSTEIN's new accuracy line, it offers new interpolated machining options for components, which greatly increases the range of parts that can be processed with the turning machine.



*“Absolute zero backlash, maximum rigidity, optimum synchronization properties and the large hollow shaft for powering the tool drive combine to produce a high-precision gearbox solution with utmost torsional stiffness for the upper revolver.”*

Jakob Friedrich  
Development engineer at  
INDEX-Werke GmbH & Co. KG Hahn & Tessen



## Extreme dynamics and rotation

Electroimpact is an established global market leader in the development and manufacture of tools and automation systems for the aerospace industry. Working closely with Electroimpact, the WITTENSTEIN engineers developed a revised AFP machine design in the form of the Galaxie® gearbox. Increased productivity, reduced load on the machine components and improved positioning accuracy makes it possible to manufacture large parts such as spars and the shell of aircraft wings in one piece.

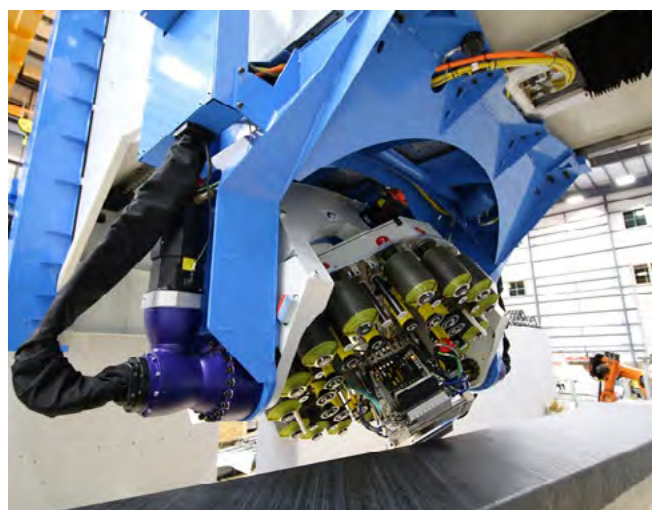

*“The performance of these machines marks a quantum leap over our previous work. The great thing about it is that we don't have to demand as much from the process.”*

Todd Rudberg  
Director of AFP, Electroimpact



# Galaxie®

Gearbox + adapter plate  
= maximum flexibility



## Galaxie® G

Custom-designed backlash-free gearbox with optional coaxial planetary input stage and adapter plate.



## Galaxie® GH

Galaxie® gearbox with hypoid input stage and adapter plate – with additional coaxial input stage and hollow shaft as an option.

Gearbox + motor  
= ultra-compact hollow shaft actuator



## Galaxie® D

Hollow-shaft compact drive with integrated permanent magnet synchronous motor with standard encoder systems and water cooling.

Gearbox + drive interface  
= large hollow shaft + extremely short design



## Galaxie® GS

Compact, customized backlash-free gearbox with hollow shaft and input drive interface.



# Galaxie®

## Rigidity

Positioning with extreme load fluctuations up to 5 times better than the market standard

## TCO

Up to 40% increase in productivity by using disruptive technology

## Torque density

Triple the torque compared to geometrically comparable gearboxes

## Damping properties

Hydrodynamic lubricating film on the teeth provides damping properties



## Energy efficiency

Up to 50% lower energy consumption through downsizing

## Overload capacity

Surface contact of the teeth enables up to triple overload of the maximum torque

## Mass customized

A drive system tailored perfectly to your application without compromise

## Long service life

Virtually wear-free toothing based on a logarithmic spiral in place of an involute

## Backlash-free

Over the entire service life

Find out more about the Galaxie® gearbox



Whitepaper on the Galaxie® gearbox



# Miniaturized Galaxie®

The compact precision gearbox with the largest hollow shaft

With the miniaturized Galaxie®, we have taken the functional principle of our classic Galaxie® a step further. The result: innovative kinematics enabling almost full surface contact during power transmission – with an extremely compact footprint. Thanks to this unique concept, the considerably smaller Galaxie® performs significantly better than established gearbox types with the same diameter in almost all performance dimensions. It combines the highest levels of rigidity, torque density and overload capacity with a very large hollow shaft and maintains zero backlash throughout its entire service life.

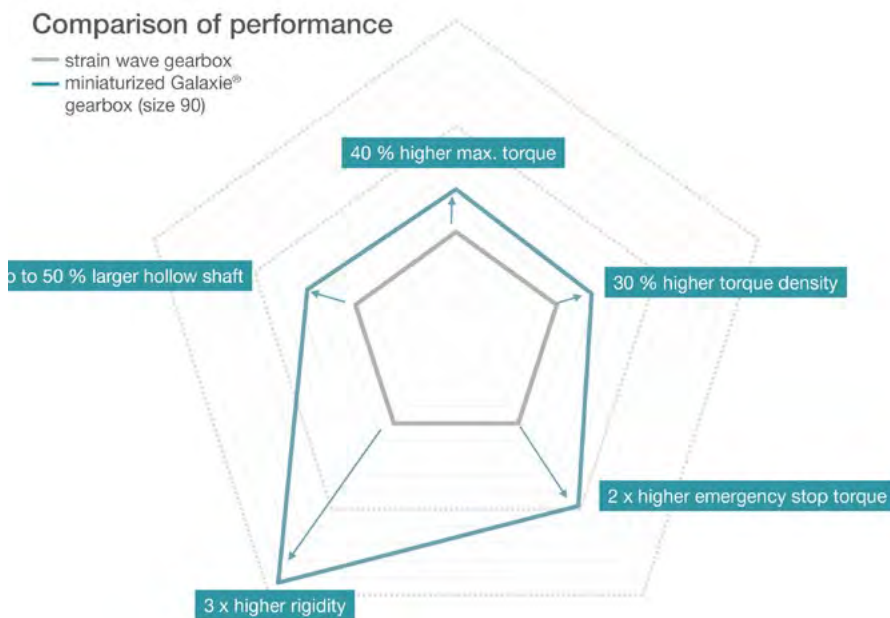

The miniaturized Galaxie® compared to conventional strain wave gears:

- 40% higher maximum torque  $T_{max}$
- 30% higher torque density
- 3 times higher rigidity over the entire torque range
- Up to 50% larger hollow shaft
- Zero backlash over the entire service life



## Surgical Robotics Industry Awards 2023: miniaturized Galaxie® honored

Compact hollow-shaft gearbox triumphs in the Groundbreaking Technology category

The miniaturized Galaxie® from WITTENSTEIN SE has emerged victorious at the Surgical Robotics Industry Awards 2023: It impressed the medical robotic community in the Groundbreaking Technology category and successfully prevailed over nine other finalists.

# Miniaturized Galaxie®

## Space compatibility

- Enables quick and simple integration into existing concepts

## Extremely high rigidity

- Permits higher acceleration rates
- Reduces vibrations in the system
- Enables faster and more accurate positioning
- Increases precision, e.g. of medical robots

## Absolute zero backlash

- Enhances product quality
- Enables greater precision in the application



## Larger hollow shaft

- Minimizes the risk of cable breakage
- Enables integration of media or components

## High torque density

- Enables downsizing in the drive train or upgrading with the same installation space
- Reduces the weight in the drive train
- Offers significant safety reserves in case of overload



Find out more about the  
miniaturized Galaxie®







---

---

---

---

---

---

---

---

---

---

---

---

---

---

---

---

---

---

---

---

---

---

---

# Contact

WITTENSTEIN SE  
Walter-Wittenstein-Straße 1  
97999 Igersheim  
Germany

Email: [info@wittenstein.de](mailto:info@wittenstein.de)  
Tel.: +49 7931 493-0





WITTENSTEIN SE · Walter-Wittenstein-Straße 1 · 97999 Igersheim, Germany

**WITTENSTEIN – one with the future**

**[www.wittenstein.de](http://www.wittenstein.de)**